



# 65V, 200mA, Low-Quiescent-Current Linear Regulators in TDFN

MAX5084/MAX5085

## General Description

The MAX5084/MAX5085 high-voltage linear regulators operate from an input voltage range of 6.5V to 65V and deliver up to 200mA of output current. These devices consume only 50 $\mu$ A (typ) of quiescent current with no load and 6 $\mu$ A (typ) in shutdown (EN pulled low). Both devices include a SET input, which when connected to ground, selects a preset output voltage of 5V (MAX5084) or 3.3V (MAX5085). Alternatively, the output voltage can be adjusted from 2.54V to 11V by connecting the SET pin to the regulator's output through a resistive divider network. The MAX5084/MAX5085 also include an OUT\_SENSE pin, which allows remote voltage sensing right at the load, thus eliminating the voltage drop caused by the line impedance. Both devices are short-circuit protected and include thermal shutdown.

The MAX5084/MAX5085 operate over the -40°C to +125°C automotive temperature range and are available in a space-saving 3mm x 3mm thermally enhanced 6-pin TDFN package.

## Applications

Automotive  
Industrial  
Home Security  
Telecom/Networking

## Features

- ◆ Wide Operating Input Voltage Range (6.5V to 65V)
- ◆ Thermally Enhanced 3mm x 3mm 6-Pin TDFN Package Dissipates 1.905W at +70°C
- ◆ Guaranteed 200mA Output Current
- ◆ 50 $\mu$ A No-Load Supply Current
- ◆ Preset 3.3V, 5.0V, or Adjustable (from 2.54V to 11V) Output Voltage
- ◆ Remote Load Sense
- ◆ Thermal and Short-Circuit Protection
- ◆ -40°C to +125°C Operating Temperature Range
- ◆ SET Input for Adjustable Output Voltage
- ◆ Enable Input

## Ordering Information

PART	PIN-PACKAGE	TOP MARK	PKG CODE
MAX5084ATT+T	6 TDFN-EP*	AJI	T633-2
MAX5085ATT+T	6 TDFN-EP*	AJJ	T633-2

**Note:** All devices are specified over the -40°C to +125°C operating temperature range.

\*EP = Exposed paddle.

+Denotes lead-free package.

Selector Guide appears at end of data sheet.

## Typical Operating Circuit

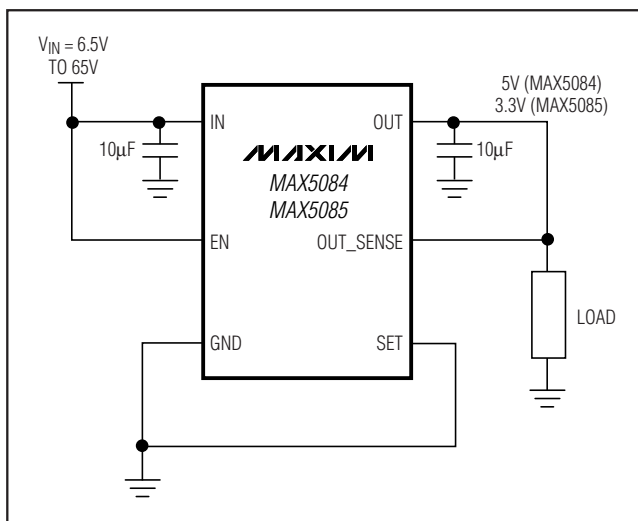

## Pin Configuration

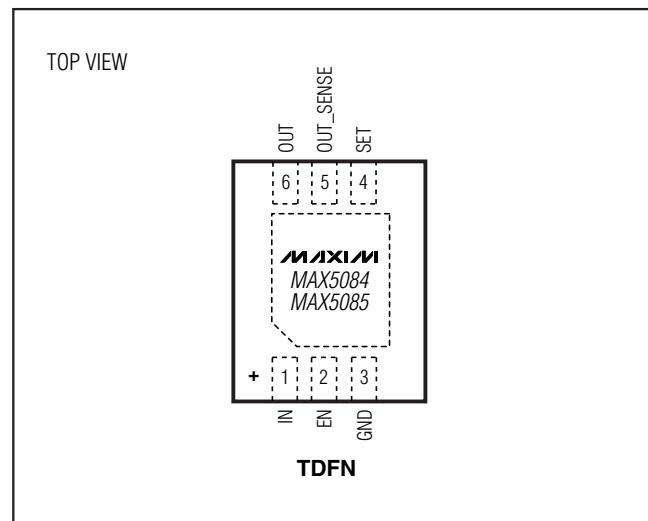

# 65V, 200mA, Low-Quiescent-Current Linear Regulators in TDFN

## ABSOLUTE MAXIMUM RATINGS

IN to GND .....-0.3V to +80V  
 EN to GND .....-0.3V to +80V  
 SET, OUT, OUT\_SENSE  
 to GND .....-0.3V to the lesser of (VIN + 0.3V) or +13.2V  
 OUT\_SENSE to OUT .....-0.3V to +0.3V  
 Short-Circuit Duration (VIN ≤ 65V) .....Continuous  
 Maximum Current into Any Pin (except IN and OUT) .....±20mA  
 Continuous Power Dissipation (TA = +70°C)  
 6-Pin TDFN-EP (derate 23.8mW/°C above +70°C) ...1904.8mW\*

Thermal Resistance:

θJA .....42°C/W  
 θJC .....8.5°C/W  
 Operating Temperature Range .....-40°C to +125°C  
 Junction Temperature .....+150°C  
 Storage Temperature Range .....-65°C to +150°C  
 Lead Temperature (soldering, 10s) .....+300°C

\*As per JEDEC51 Standard (Multilayer Board).

Stresses beyond those listed under "Absolute Maximum Ratings" may cause permanent damage to the device. These are stress ratings only, and functional operation of the device at these or any other conditions beyond those indicated in the operational sections of the specifications is not implied. Exposure to absolute maximum rating conditions for extended periods may affect device reliability.

## ELECTRICAL CHARACTERISTICS

(VIN = 14V, IOUT = 1mA, CIN = COUT = 10µF, VEN = 2.4V, TA = TJ = -40°C to +125°C, unless otherwise noted. Typical specifications are at TA = +25°C, unless otherwise noted.) (Note 1)

PARAMETER	SYMBOL	CONDITIONS	MIN	TYP	MAX	UNITS
Input Voltage Range	VIN	VIN > VOUT + 1.5V	6.5		65.0	V
Supply Current	IQ	Measured at GND, SET = GND	IOUT = 0	51	140	µA
			IOUT = 100µA	51	140	
			IOUT = 200mA	2	4	mA
Shutdown Supply Current	ISHDN	VEN ≤ 0.4V		6	16	µA
<b>REGULATOR</b>						
Guaranteed Output Current	IOUT	VOUT = VOUT(NOM) ±4%	200			mA
Output Voltage Accuracy	VOUT	VIN = 9V to 16V, SET = GND, IOUT = 5mA to 200mA, OUT_SENSE connected to OUT (MAX5084)	4.8	5.0	5.2	V
		VIN = 6.5V to 21V, SET = GND, IOUT = 5mA to 100mA, OUT_SENSE connected to OUT (MAX5084)	4.85	5.0	5.15	
		VIN = 9V to 16V, SET = GND, IOUT = 5mA to 50mA, OUT_SENSE connected to OUT (MAX5084)	4.9		5.1	
		VIN = 6.5V, SET = GND, IOUT = 1mA to 200mA, OUT_SENSE connected to OUT (MAX5085)	3.168	3.300	3.432	
Output Voltage Range		IOUT = 5mA, adjustable output	2.54		11.00	V
Dropout Voltage	ΔVDO	IOUT = 200mA, VOUT = 5V, MAX5084 (Note 2)		0.9	1.5	V
Startup Response Time		Rising edge of VIN to rising edge of VOUT, RL = 500Ω (Note 3)		400		µs
Line Regulation	ΔVOUT/ ΔVIN	VIN from 8V to 65V	MAX5084, SET = GND	-1	+1	mV/V
			MAX5085, SET = GND	-0.5	+0.5	
		VIN from 14V to 65V	Adjustable output from 2.54V to 11V	-0.5	+0.5	

# 65V, 200mA, Low-Quiescent-Current Linear Regulators in TDFN

MAX5084/MAX5085

## ELECTRICAL CHARACTERISTICS (continued)

( $V_{IN} = 14V$ ,  $I_{OUT} = 1mA$ ,  $C_{IN} = C_{OUT} = 10\mu F$ ,  $V_{EN} = 2.4V$ ,  $T_A = T_J = -40^{\circ}C$  to  $+125^{\circ}C$ , unless otherwise noted. Typical specifications are at  $T_A = +25^{\circ}C$ , unless otherwise noted.) (Note 1)

PARAMETER	SYMBOL	CONDITIONS	MIN	TYP	MAX	UNITS
Enable Voltage	$V_{EN}$	Regulator on	2.4			V
		Regulator off	0.4			
Enable Input Current	$I_{EN}$	$V_{EN} = 2.4V$	0.5 1			$\mu A$
		$V_{EN} = 14V$	4 8			
		$V_{EN} = 65V$	14 35			
OUT to OUT_SENSE Internal Resistor	$R_{OUT\_SENSE}$	$I_{OUT\_SENSE} = 10mA$	8	15	24	$\Omega$
SET Reference Voltage	$V_{SET}$	$I_{OUT} = 10mA$	1.220	1.251	1.280	V
SET Input Leakage Current	$I_{SET}$	$V_{SET} = 1.251V$	-100	+1	+100	nA
Load Regulation	$\Delta V_{OUT}/\Delta I_{OUT}$	$I_{OUT}$ from 1mA to 200mA, $OUT\_SENSE = OUT$	MAX5084, SET = GND	0.3	1	mV/mA
			MAX5085, SET = GND	0.3	1	
			Adjustable output from 2.54V to 11V	0.5	2	
Power-Supply Rejection Ratio	PSRR	$I_{OUT} = 10mA$ , $f = 100Hz$ , $V_{IN\_RIPPLE} = 500mV_{p-p}$ , $V_{OUT} = 5V$	55			dB
Short-Circuit Current	$I_{SC}$	$V_{IN} = 8V$ to $14V$	220	340	500	mA
		$V_{IN} = 65V$	340			
Thermal Shutdown	$T_{SHDN}$		+160			$^{\circ}C$
Thermal Shutdown Hysteresis	$T_{HYST}$		10			$^{\circ}C$

**Note 1:** Specifications at  $-40^{\circ}C$  are guaranteed by design and not production tested.

**Note 2:** Dropout voltage is defined as  $(V_{IN} - V_{OUT})$  when  $V_{OUT}$  is 100mV below the value of  $V_{OUT}$  when  $V_{IN} = V_{OUT} + 3V$ .

**Note 3:** Startup time measured from 50% of  $V_{IN}$  to 90% of  $V_{OUT}$ .

# 65V, 200mA, Low-Quiescent-Current Linear Regulators in TDFN

## Typical Operating Characteristics

( $V_{IN} = 14V$ ,  $C_{IN} = C_{OUT} = 10\mu F$ ,  $V_{EN} = V_{IN}$ ,  $T_A = +25^\circ C$ , unless otherwise noted.)

**OUTPUT VOLTAGE vs. INPUT VOLTAGE**

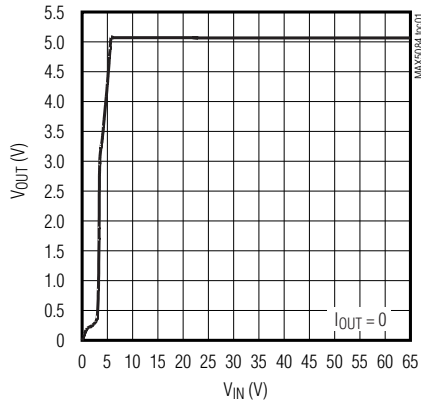

**NO-LOAD GROUND CURRENT vs. TEMPERATURE**

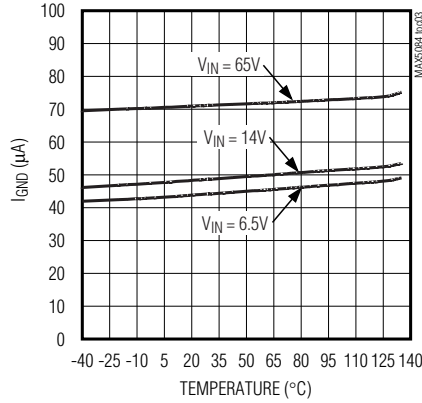

**SHUTDOWN SUPPLY CURRENT vs. TEMPERATURE**

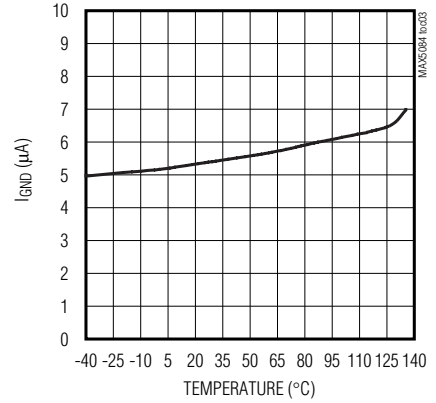

**OUTPUT VOLTAGE vs. TEMPERATURE**

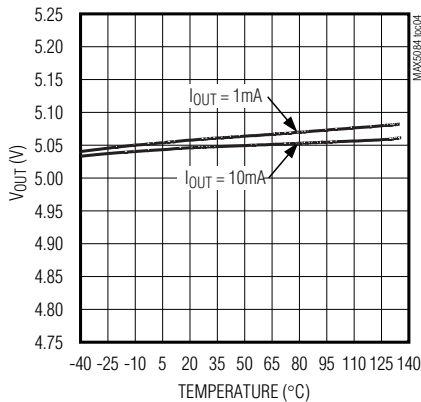

**GROUND CURRENT vs. TEMPERATURE**

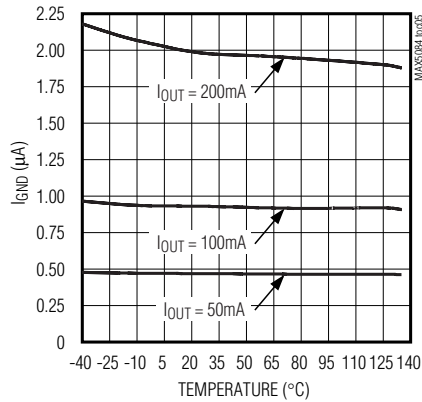

**OUTPUT VOLTAGE vs. LOAD CURRENT AND TEMPERATURE**

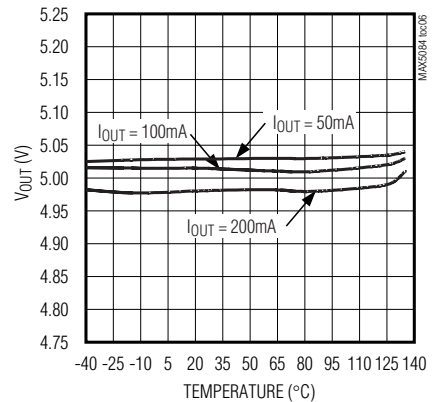

**DROPOUT VOLTAGE vs. LOAD CURRENT**

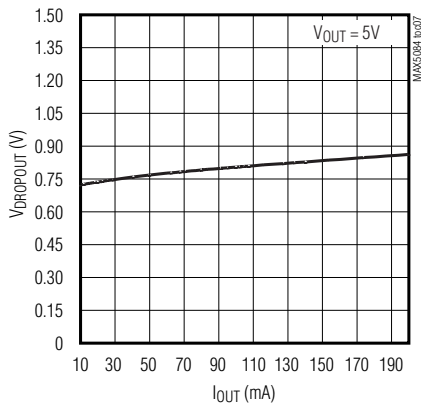

**POWER-SUPPLY REJECTION RATIO vs. FREQUENCY**

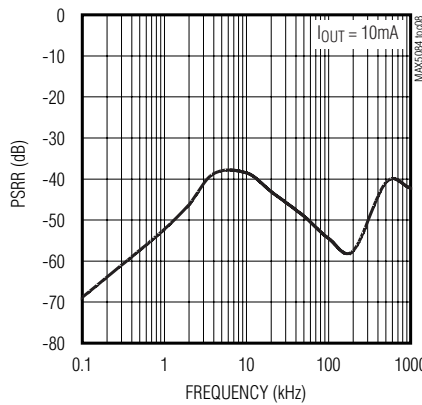

**LINE-TRANSIENT RESPONSE**

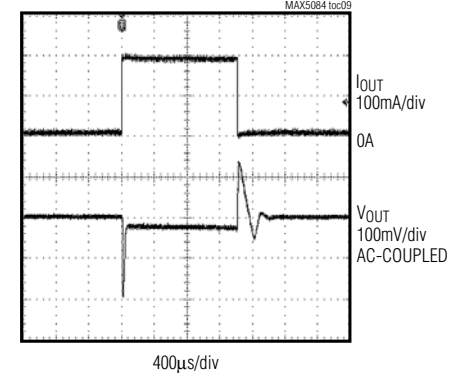

# 65V, 200mA, Low-Quiescent-Current Linear Regulators in TDFN

## Typical Operating Characteristics (continued)

( $V_{IN} = 14V$ ,  $C_{IN} = C_{OUT} = 10\mu F$ ,  $V_{EN} = V_{IN}$ ,  $T_A = +25^\circ C$ , unless otherwise noted.)

MAX5084/MAX5085

**INPUT VOLTAGE STEP RESPONSE**

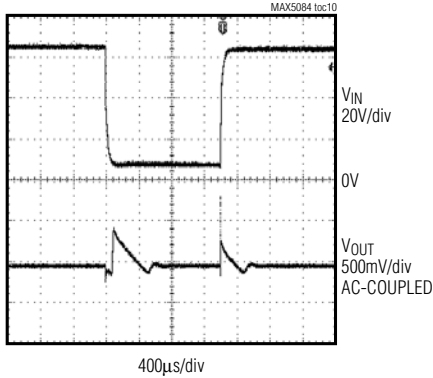

**STARTUP RESPONSE**

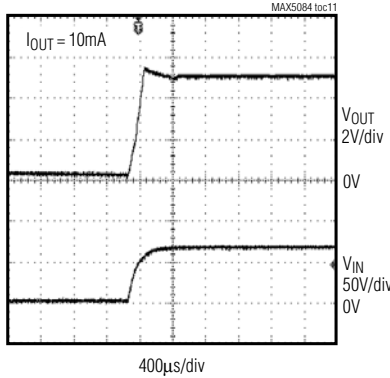

**ENABLE STARTUP RESPONSE**

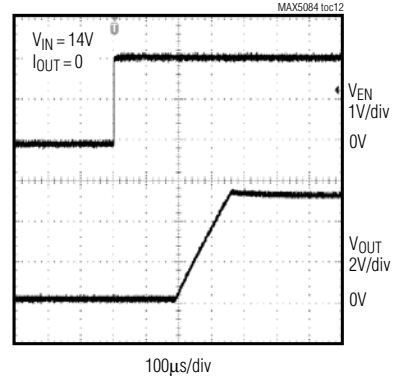

**ENABLE STARTUP RESPONSE**

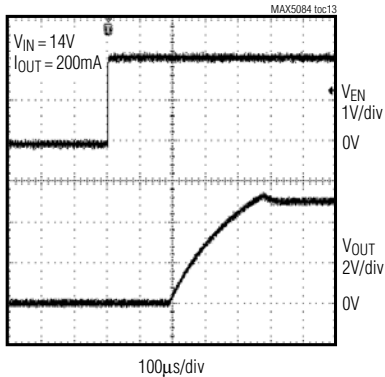

**ENABLE STARTUP RESPONSE**

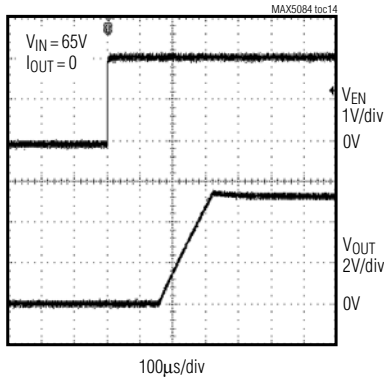

**ENABLE STARTUP RESPONSE**

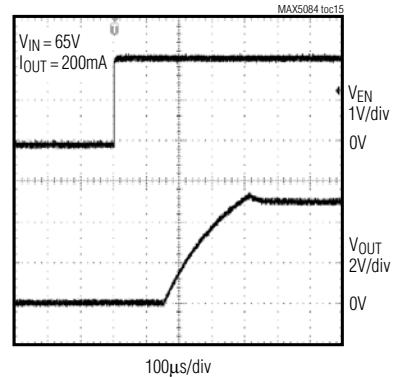

**SHUTDOWN RESPONSE**

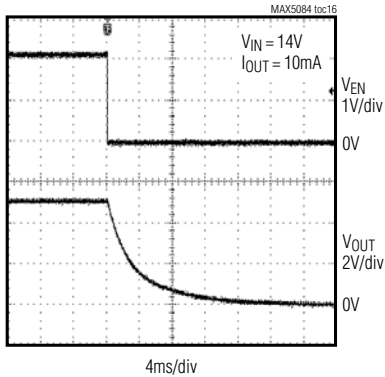

**GROUND CURRENT DISTRIBUTION  
( $T_A = -40^\circ C$ )**

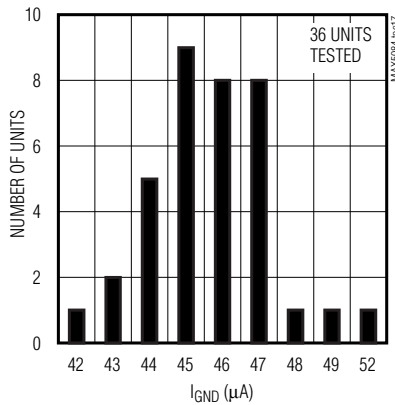

**GROUND CURRENT DISTRIBUTION  
( $T_A = +125^\circ C$ )**

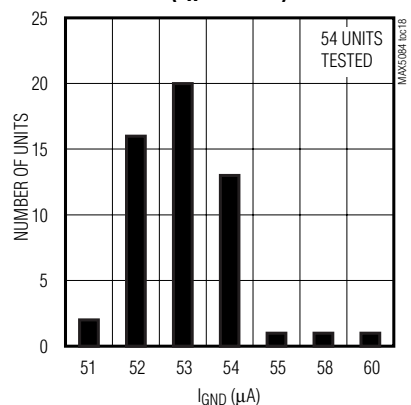

# 65V, 200mA, Low-Quiescent-Current Linear Regulators in TDFN

## Pin Description

PIN	NAME	FUNCTION
1	IN	Regulator Supply Input. Supply voltage ranges from 6.5V to 65V. Bypass with a 10 $\mu$ F capacitor to GND.
2	EN	Enable Input. Force EN high to turn on the regulator. Pull EN low to place the device in a low-power shutdown mode. EN has an internal 5M $\Omega$ resistor to GND.
3	GND	Ground
4	SET	Feedback Input for Setting the Output Voltage. Connect SET to GND for a fixed 5V output (MAX5084), or 3.3V output (MAX5085). Connect to a resistive divider from OUT to SET to GND to adjust the output voltage from 2.54V to 11V.
5	OUT_SENSE	Output Voltage Sensing Input. OUT_SENSE is used to Kelvin sense the output voltage in fixed-output voltage mode. OUT_SENSE can be left floating or connected directly to the load for accurate load regulation.
6	OUT	Regulator Output. Bypass OUT to GND with a minimum 10 $\mu$ F ceramic capacitor.
—	EP	Exposed Pad. Connect to GND for heatsinking.

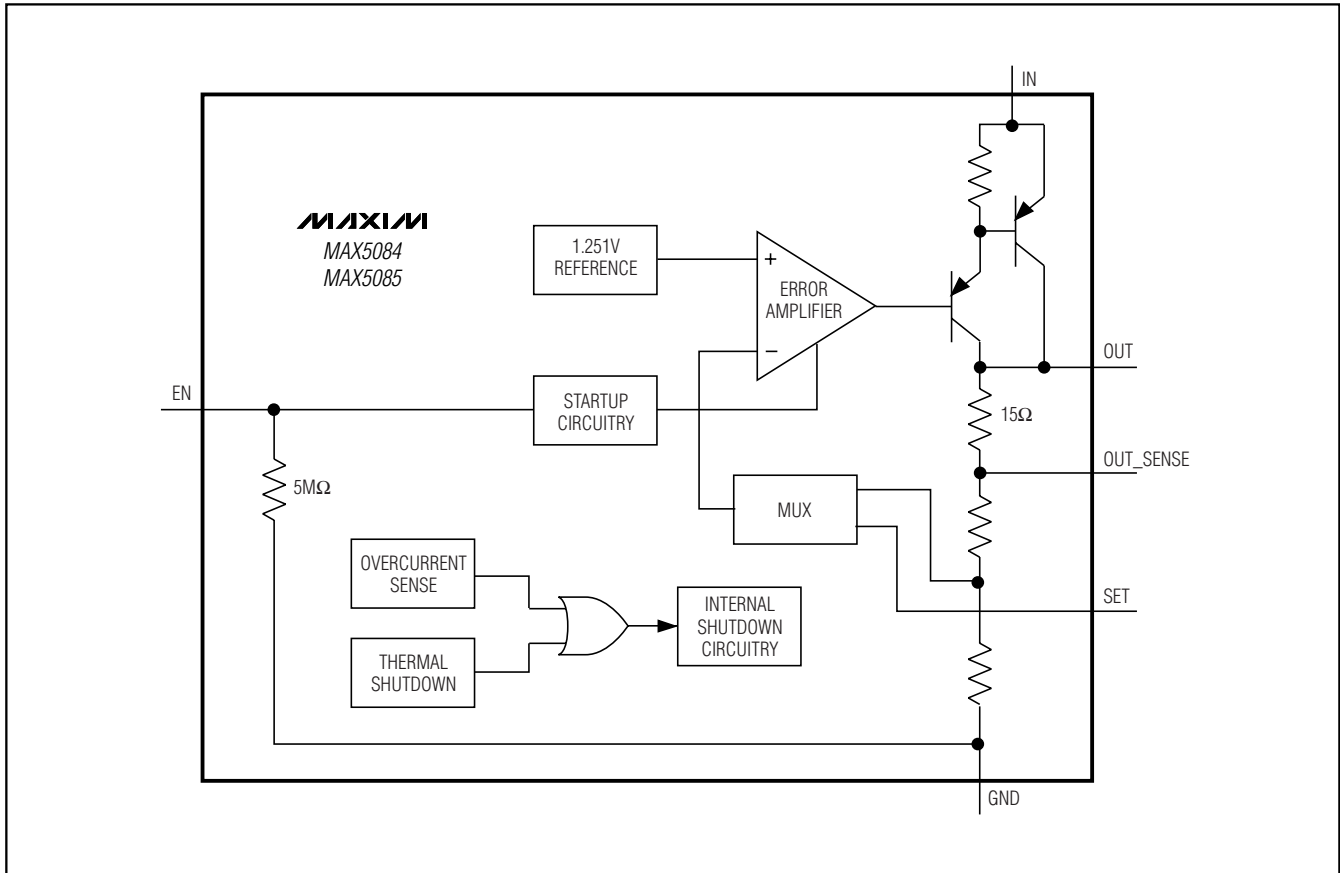

Figure 1. Block Diagram

# 65V, 200mA, Low-Quiescent-Current Linear Regulators in TDFN

## Detailed Description

The MAX5084/MAX5085 are high-voltage linear regulators with a 6.5V to 65V input voltage range. The devices guarantee 200mA output current and are available with preset output voltages of 3.3V or 5V. Both devices can be used to provide adjustable outputs from 2.54V to 11V by connecting a resistive divider from OUT to SET to GND. Thermal shutdown and short-circuit protection are provided to prevent damage during overtemperature and overcurrent conditions. An output sense pin (OUT\_SENSE) provides for Kelvin sensing of the output voltage, thereby reducing the error caused by internal and external resistances. An enable input (EN) allows the regulators to be turned on/off through a logic-level voltage. Driving EN high turns on the device, while driving EN low places the device in a low-power shutdown mode. In shutdown, the supply current reduces to 6 $\mu$ A (typ). Both devices operate over the -40°C to +125°C temperature range and are available in a 3mm x 3mm, 6-pin TDFN package capable of dissipating 1.905W at T<sub>A</sub> = +70°C.

## Regulator

The regulator accepts an input voltage range from 6.5V to 65V. The MAX5084/MAX5085 offer fixed-output voltages of 5V and 3.3V, respectively. The output voltage is also adjustable from 2.54V to 11V by connecting an external resistive divider network between OUT, SET, and GND (see R1 and R2 in Figure 2). The MAX5084/MAX5085 automatically determine the feedback path depending on the voltage at SET.

## Enable Input (EN)

EN is a logic-level enable input, which turns the MAX5084/MAX5085 on/off. Drive EN high to turn on the device and drive EN low to place the device in shutdown. When in shutdown, the MAX5084/MAX5085 typically draw 6 $\mu$ A of supply current. EN can withstand voltages up to 65V, allowing EN to be connected to IN for an always-on operation. EN has an internal 5M $\Omega$  resistor to GND.

## Remote Sensing (OUT\_SENSE)

OUT\_SENSE provides for Kelvin sensing of the fixed output voltage, thus eliminating errors due to the voltage drop in the trace resistance between OUT and the load. OUT\_SENSE is internally connected to OUT through a 15 $\Omega$  resistor (Figure 1), and can be left floating when remote sensing is not required. However, if accurate output voltage regulation at the load is required, then connect OUT\_SENSE directly to the load.

## Thermal Protection

When the junction temperature exceeds +160°C, an internal thermal sensor signals the shutdown logic to turn off the pass transistor and allows the IC to cool. The thermal sensor turns the pass transistor on again after the junction temperature cools by 10°C. This results in a cycled output during continuous thermal overload conditions. Thermal protection protects the MAX5084/MAX5085 in the event of fault conditions. For continuous operation, do not exceed the maximum junction temperature rating of +150°C.

## Output Short-Circuit Current Limit

The MAX5084/MAX5085 feature a 340mA current limit. The output can be shorted to GND for an indefinite period of time without damage to the device. During a short circuit, the power dissipated across the pass transistor can quickly heat the device. When the die temperature reaches +160°C, the MAX5084/MAX5085 shut down and automatically restart after the die temperature cools by 10°C. This results in a pulsed output operation.

## Applications Information

### Output Voltage Setting

The MAX5084/MAX5085 feature Dual Mode™ operation: they operate in either a preset output voltage mode or an adjustable output voltage mode. Connect SET to GND for preset output voltage operation. In preset mode, internal feedback resistors set the MAX5084's internal linear regulator to 5V, and the MAX5085's internal linear regulator to 3.3V. In adjustable mode, select an output from 2.54V to 11V using a resistive divider (see R1 and R2 in Figure 2) connected from OUT to SET to GND. In adjustable mode, first select the resistor from SET to GND (R2) in the 1k $\Omega$  to 100k $\Omega$  range. The resistor from OUT to SET (R1) is then calculated by:

$$R1 = R2 \times \left( \frac{V_{OUT}}{V_{SET}} - 1 \right)$$

where V<sub>SET</sub> = 1.251V.

### Available Output Current Calculation

The MAX5084/MAX5085 provide up to 200mA of continuous output current. The input voltage extends to 65V. Package power dissipation limits the amount of output current available for a given input/output voltage and ambient temperature. Figure 3 depicts the maximum power dissipation curve for these devices.

Dual Mode is a trademark of Maxim Integrated Products, Inc.

# 65V, 200mA, Low-Quiescent-Current Linear Regulators in TDFN

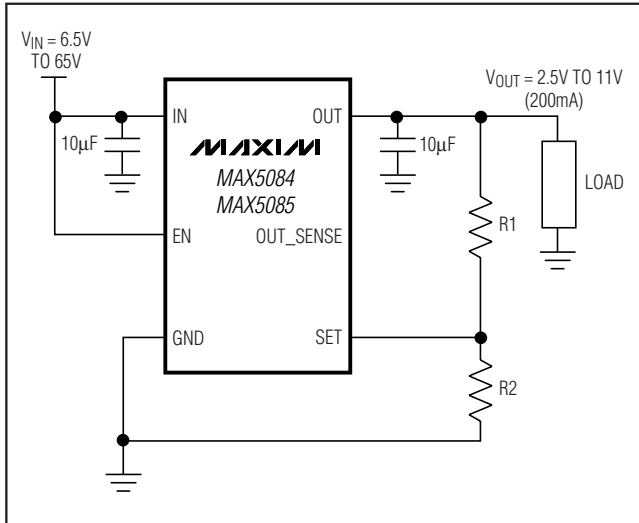

Figure 2. Adjustable Output Voltage Operation

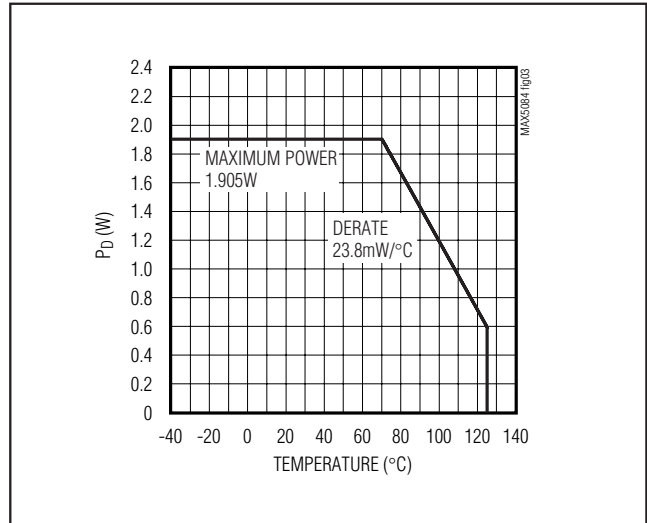

Figure 3. Calculated Maximum Power Dissipation vs. Temperature

Use Figure 3 to determine the allowable package dissipation for a given ambient temperature. Alternately, use the following formula to calculate the allowable package dissipation:

$$P_D = \begin{cases} 1.905\text{W} & \text{for } T_A \leq +70^\circ\text{C} \\ 1.905\text{W} - 0.0238\text{W}/^\circ\text{C} \times (T_A - 70^\circ\text{C}) & \text{for } +70^\circ\text{C} < T_A \leq +125^\circ\text{C} \end{cases}$$

After determining the allowable package dissipation, calculate the maximum output current using the following formula:

$$I_{OUT(MAX)} = \frac{P_D}{V_{IN} - V_{OUT}} \leq 200\text{mA}$$

The above equations do not include the negligible power dissipation from self-heating due to the device's ground current.

Example 1:

$$T_A = +85^\circ\text{C}$$

$$V_{IN} = 14\text{V}$$

$$V_{OUT} = 5\text{V}$$

Find the maximum allowable output current. First calculate package dissipation at the given temperature as follows:

$$P_D = 1.905\text{W} - 0.0238\text{W}/^\circ\text{C} (85^\circ\text{C} - 70^\circ\text{C}) = 1.548\text{W}$$

Then determine the maximum output current:

$$I_{OUT(MAX)} = \frac{1.548\text{W}}{14\text{V} - 5\text{V}} = 172\text{mA}$$

Example 2:

$$T_A = +125^\circ\text{C}$$

$$V_{IN} = 14\text{V}$$

$$V_{OUT} = 3.3\text{V}$$

Calculate package dissipation at the given temperature as follows:

$$P_D = 1.905\text{W} - 0.0238\text{W}/^\circ\text{C} (125^\circ\text{C} - 70^\circ\text{C}) = 596\text{mW}$$

And establish the maximum output current:

$$I_{OUT(MAX)} = \frac{596\text{mW}}{14\text{V} - 3.3\text{V}} = 56\text{mA}$$

Example 3:

$$T_A = +50^\circ\text{C}$$

$$V_{IN} = 9\text{V}$$

$$V_{OUT} = 5\text{V}$$



# 65V, 200mA, Low-Quiescent-Current Linear Regulators in TDFN

Calculate package dissipation at the given temperature as follows:

$$P_D = 1.905W$$

Find the maximum output current:

$$I_{OUT(MAX)} = \frac{1.905W}{9V - 5V} = 476mA \quad (I_{OUTMAX} = 200mA)$$

In example 3, the maximum output current is calculated as 476mA, however, the maximum output current cannot exceed 200mA.

Alternately, use Figure 4 to quickly determine allowable maximum output current for selected ambient temperatures.

## Output Capacitor Selection and Regulator Stability

For stable operation over the full temperature range and with load currents up to 200mA, use a 10µF (min) output capacitor with an ESR < 0.5Ω. To reduce noise and improve load-transient response, stability, and power-supply rejection, use larger output capacitor values such as 22µF.

Some ceramic dielectrics exhibit large capacitance and ESR variations with temperature. For dielectric capacitors such as Z5U and Y5V, use 22µF or more to ensure stability at temperatures below -10°C. With X7R or X5R dielectrics, 10µF should be sufficient at all operating temperatures. For high-ESR tantalum capacitors use 22µF or more to maintain stability. To improve power-supply rejection and transient response, use a minimum 10µF capacitor between IN and GND.

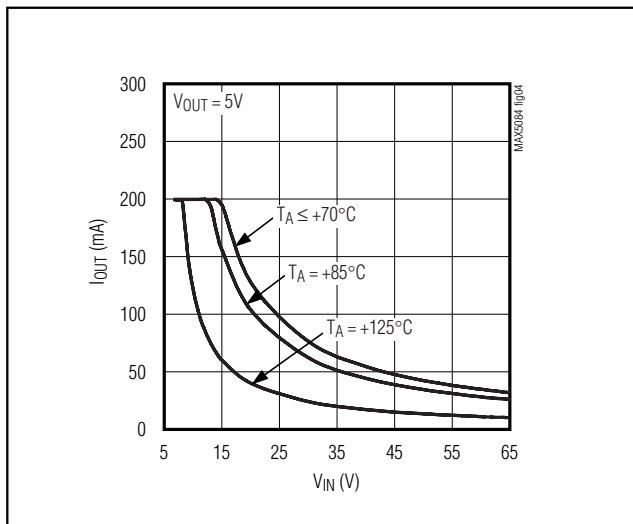

Figure 4. Calculated Maximum Output Current vs. Input Voltage

MAX5084/MAX5085

## Selector Guide

PART	TEMP RANGE	OUTPUT VOLTAGE (V)
MAX5084ATT+T	-40°C to +125°C	5 or adjustable
MAX5085ATT+T	-40°C to +125°C	3.3 or adjustable

## Chip Information

PROCESS: BiCMOS

# 65V, 200mA, Low-Quiescent-Current Linear Regulators in TDFN

## Package Information

(The package drawing(s) in this data sheet may not reflect the most current specifications. For the latest package outline information, go to [www.maxim-ic.com/packages](http://www.maxim-ic.com/packages).)

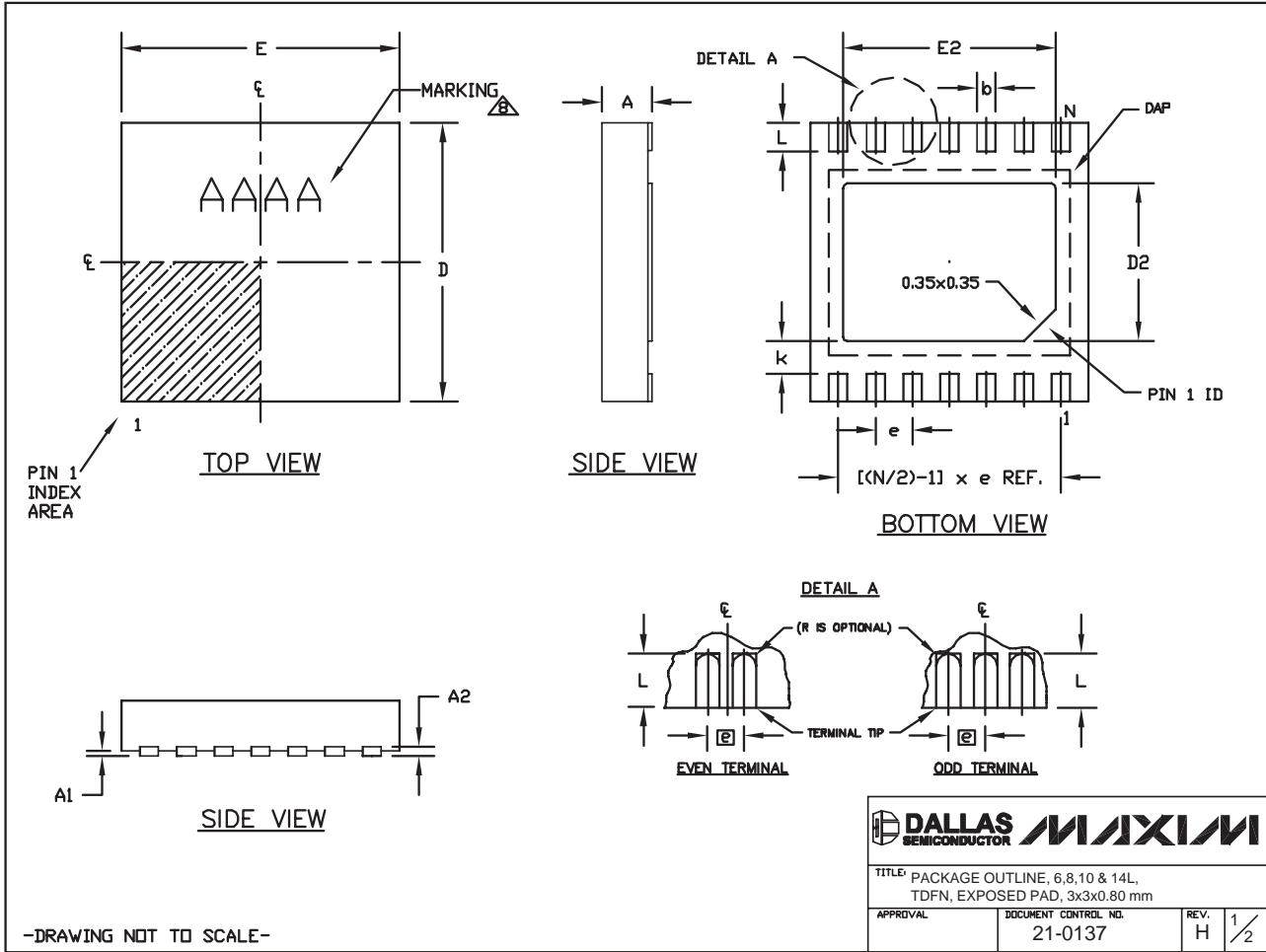

# 65V, 200mA, Low-Quiescent-Current Linear Regulators in TDFN

## Package Information (continued)

(The package drawing(s) in this data sheet may not reflect the most current specifications. For the latest package outline information, go to [www.maxim-ic.com/packages](http://www.maxim-ic.com/packages).)

MAX5084/MAX5085

COMMON DIMENSIONS		
SYMBOL	MIN.	MAX.
A	0.70	0.80
D	2.90	3.10
E	2.90	3.10
A1	0.00	0.05
L	0.20	0.40
k	0.25 MIN.	
A2	0.20 REF.	

PACKAGE VARIATIONS							
PKG. CODE	N	D2	E2	e	JEDEC SPEC	b	[(N/2)-1] x e
T633-1	6	1.50±0.10	2.30±0.10	0.95 BSC	MO229 / WEEA	0.40±0.05	1.90 REF
T633-2	6	1.50±0.10	2.30±0.10	0.95 BSC	MO229 / WEEA	0.40±0.05	1.90 REF
T833-1	8	1.50±0.10	2.30±0.10	0.65 BSC	MO229 / WEEC	0.30±0.05	1.95 REF
T833-2	8	1.50±0.10	2.30±0.10	0.65 BSC	MO229 / WEEC	0.30±0.05	1.95 REF
T833-3	8	1.50±0.10	2.30±0.10	0.65 BSC	MO229 / WEEC	0.30±0.05	1.95 REF
T1033-1	10	1.50±0.10	2.30±0.10	0.50 BSC	MO229 / WEED-3	0.25±0.05	2.00 REF
T1033-2	10	1.50±0.10	2.30±0.10	0.50 BSC	MO229 / WEED-3	0.25±0.05	2.00 REF
T1433-1	14	1.70±0.10	2.30±0.10	0.40 BSC	----	0.20±0.05	2.40 REF
T1433-2	14	1.70±0.10	2.30±0.10	0.40 BSC	----	0.20±0.05	2.40 REF

### NOTES:

- ALL DIMENSIONS ARE IN mm. ANGLES IN DEGREES.
- COPLANARITY SHALL NOT EXCEED 0.08 mm.
- WARPAGE SHALL NOT EXCEED 0.10 mm.
- PACKAGE LENGTH/PACKAGE WIDTH ARE CONSIDERED AS SPECIAL CHARACTERISTIC(S).
- DRAWING CONFORMS TO JEDEC MO229, EXCEPT DIMENSIONS "D2" AND "E2", AND T1433-1 & T1433-2.
- "N" IS THE TOTAL NUMBER OF LEADS.
- NUMBER OF LEADS SHOWN ARE FOR REFERENCE ONLY.
-  MARKING IS FOR PACKAGE ORIENTATION REFERENCE ONLY.

-DRAWING NOT TO SCALE-

			
<b>TITLE</b> PACKAGE OUTLINE, 6,8,10 & 14L, TDFN, EXPOSED PAD, 3x3x0.80 mm			
<b>APPROVAL</b>	<b>DOCUMENT CONTROL NO.</b>	<b>REV.</b>	
	21-0137	H	2/2

Maxim cannot assume responsibility for use of any circuitry other than circuitry entirely embodied in a Maxim product. No circuit patent licenses are implied. Maxim reserves the right to change the circuitry and specifications without notice at any time.

**Maxim Integrated Products, 120 San Gabriel Drive, Sunnyvale, CA 94086 408-737-7600** \_\_\_\_\_ 11